

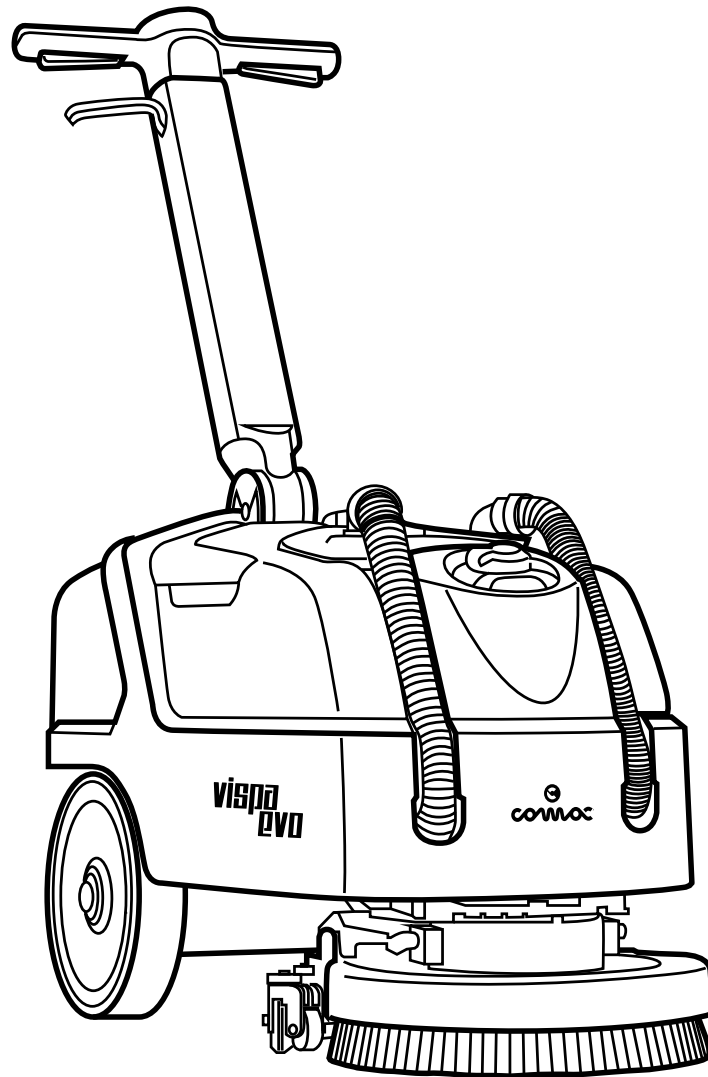

vispa evo *essential*

vispa xl *essential*



PROFESSIONAL SCRUBBING MACHINES

USE AND MAINTENANCE MANUAL



CONTENTS

CONTENTS	3
LOCATION OF THE MAIN MACHINE COMPONENTS	5
GENERAL DESCRIPTION	5
GENERAL SAFETY REGULATIONS.....	5
DEFINITION OF LEVELS OF WARNING	6
SYMBOLS USED IN THE MANUAL	6
PURPOSE AND CONTENT OF THE MANUAL.....	6
TARGET GROUP.....	6
PRESERVATION OF THE USER.....	7
ON CONSIGNMENT OF THE MACHINE	7
INTRODUCTORY COMMENT	7
IDENTIFICATION DATA	7
TECHNICAL DESCRIPTION.....	7
INTENDED USE.....	7
SAFETY.....	7
REGULATIONS.....	7
SERIAL NUMBER PLATE.....	7
TECHNICAL DATA	8
SYMBOLS AND LABELS USED ON THE MACHINE	8
SYMBOLS USED ON THE MACHINE.....	8
LABELS USED ON THE MACHINE.....	9
CONTROL PANEL	9
CONTROL DISPLAY.....	9
PREPARATION OF MACHINE	10
HANDLING THE PACKAGED MACHINE	10
HOW TO UNPACK THE MACHINE	10
HOW TO MOVE THE MACHINE	11
MACHINE SAFETY.....	11
TYPE OF BATTERY TO BE USED (Evo versions)	11
TYPE OF BATTERY TO BE USED (XL versions)	11
BATTERY MAINTENANCE AND DISPOSAL.....	11
INSERTING THE BATTERIES INTO THE MACHINE.....	12
CONNECTING THE BATTERIES TO THE MACHINE'S ELECTRICAL SYSTEM.....	12
RECHARGING THE BATTERIES	12
INSERTING WATER SYSTEM FILTER	14
FILLING THE SOLUTION TANK.....	14
DETERGENT SOLUTION.....	14
ASSEMBLING THE BRUSH HEAD BRUSH (SCRUBBING VERSION).....	14
ASSEMBLING THE ABRASIVE PAD (ORBITAL VERSION)	14
PREPARING TO WORK	15
STARTING WORK	16
HOUR METER	16
BATTERY CHARGE LEVEL INDICATOR	16
OVERFLOW DEVICE	16
WORKING PROGRAMS	17
SCRUBBING WITH DRYING.....	17
SCRUBBING WITHOUT DRYING	17
DRYING WITHOUT SCRUBBING	17
ADDITIONAL FUNCTIONS	18
ECO MODE.....	18
MANUAL MODE.....	18
ADJUSTMENT OF THE DETERGENT SOLUTION FLOW.....	19
SILENT-MAX FUNCTION.....	19
ALARM SCREEN.....	19
AT THE END OF THE WORK	20

ROUTINE MAINTENANCE.....	20
DRAINING THE RECOVERY TANK	21
CLEANING THE SQUEEGEE BODY.....	21
CLEANING THE BRUSH HEAD BRUSH (SCRUBBING VERSIONS)	22
CLEANING THE RECOVERY TANK FILTERS	22
EMPTYING THE SOLUTION TANK.....	22
CLEANING THE WATER SYSTEM FILTER	22
CLEANING THE VACUUM TUBE.....	23
CLEANING THE RECOVERY TANK.....	23
EXTRAORDINARY MAINTENANCE.....	23
REPLACING THE SQUEEGEE BODY RUBBER BLADES	24
REPLACING THE BRUSH HEAD BRUSH (SCRUBBING VERSION)	24
CHOOSING AND USING BRUSHES	24
TROUBLESHOOTING	26
DISPOSAL	27
EC DECLARATION OF CONFORMITY	28

LOCATION OF THE MAIN MACHINE COMPONENTS

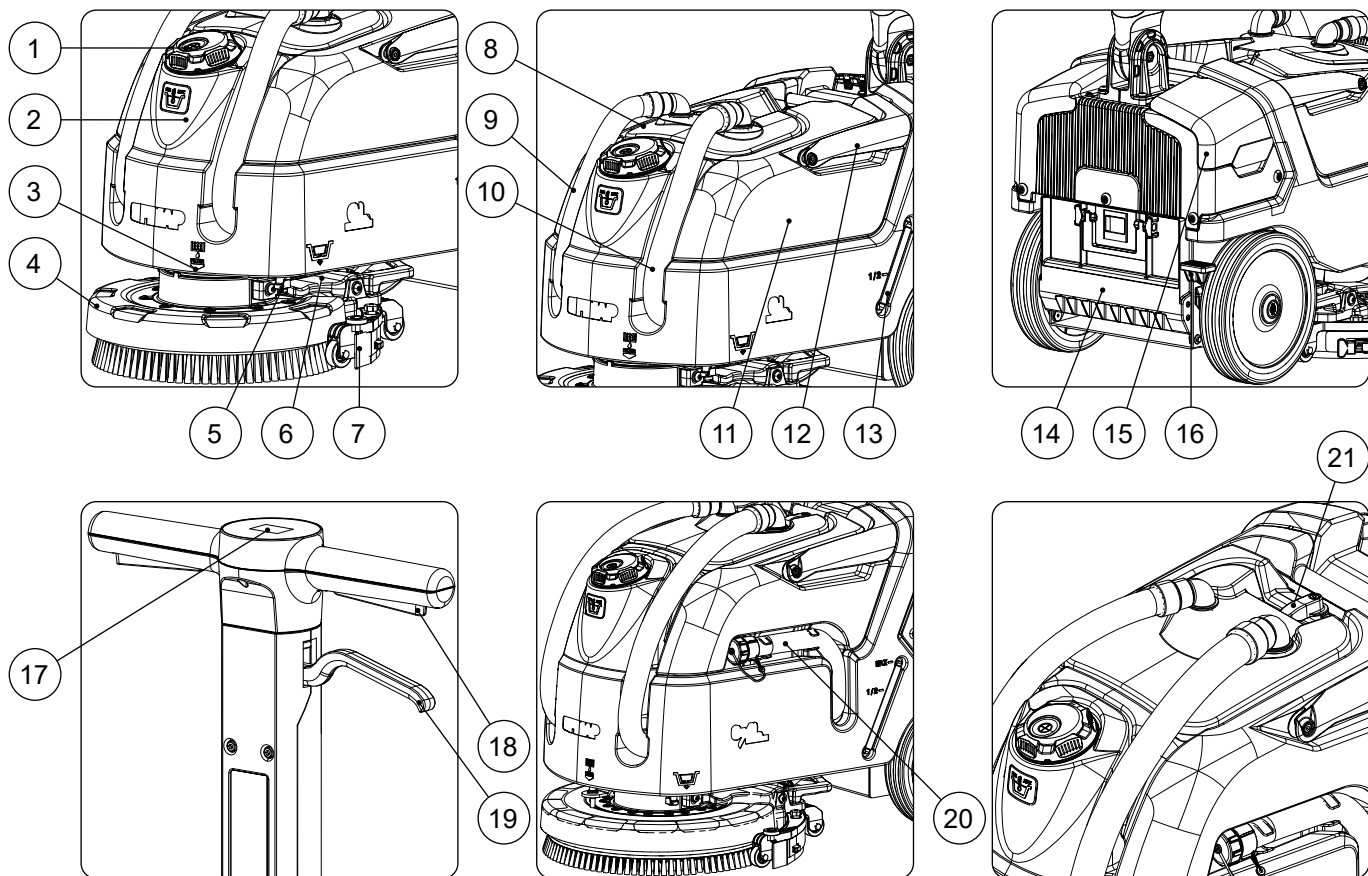

The machine's main components are the following:

- | | |
|---|---|
| <ol style="list-style-type: none"> 1. Solution tank cap. 2. Solution tank. 3. Detergent solution filter. 4. Brush head body. 5. Solution tank dumping system. 6. Detergent solution tap. 7. Squeegee body. 8. Recovery tank cover. 9. Squeegee vacuum hose. 10. Suction motor tube. | <ol style="list-style-type: none"> 11. Recovery tank. 12. Recovery tank handle. 13. Solution tank level hose. 14. Battery compartment closure carter. 15. Battery charging compartment closure carter. 16. Squeegee control pedal. 17. Control panel. 18. Dead man's lever. 19. Control column uncoupling lever. 20. Recovery tank drainage tube (XL versions). 21. Recovery tank cover prop retainer (XL versions). |
|---|---|





GENERAL DESCRIPTION

The descriptions contained in this document are not binding. The company therefore reserves the right to make any modifications at any time to elements, details, or accessory supply, as considered necessary for reasons of improvement or manufacturing/commercial requirements. The reproduction, even partial, of the text and drawings contained in this document is prohibited by law. **The company reserves the right to make any technical and/or supply modifications. The images are shown as reference only and are not binding as to the actual design and/or equipment.**













GENERAL SAFETY REGULATIONS

Before using the machine, please read the following document carefully and follow the instructions contained herein, along with the instructions in the document supplied with the machine itself, "GENERAL SAFETY REGULATIONS" (document code 10083659).

DEFINITION OF LEVELS OF WARNING

-  **DANGER:** indicates an imminent dangerous situation that, unless avoided, will result in death or serious injuries.
-  **WARNING:** Indicates a potentially dangerous situation that, unless avoided, could cause death or serious injury.
-  **ATTENTION:** Indicates a potentially dangerous situation that, unless avoided, could cause slight or moderate injuries.
-  **N.B.:** instructs the reader to pay particular attention to the topic that follows.

SYMBOLS USED IN THE MANUAL

	Open book symbol with an "i": Indicates the need to consult the instruction manual.
	Open book symbol: Tells the operator to read the user manual before using the device.
	Covered place symbol: The operations preceded by this symbol must always be carried out in a dry, covered area.
	Information symbol: Indicates additional information for the operator, to improve the use of the device.
	Warning symbol: Carefully read the sections preceded by this symbol meticulously following the instructions indicated for the safety of the operator and the device.
	Danger symbol (corrosive substances): The operator should always wear protective gloves to avoid the risk of serious injury to the hands caused by corrosive substances.
	Danger symbol (battery acid leakage): Indicates the danger of leaking acid or acid fumes from the batteries while they are being recharged.
	Danger symbol (moving carriages): Indicates that the packed product should be handled with suitable carriages that conform to legal requirements.
	Mandatory room ventilation symbol: Informs the operator that the room must be ventilated while the batteries are being recharged.
	Symbol indicating the compulsory use of protective gloves: Indicates that the operator should always wear protective gloves, to avoid the risk of serious injury to his hands from sharp objects.
	Recycling symbol: Tells the operator to carry out the operations in compliance with environmental regulations in force in the place where the appliance is being used.
	Disposal symbol: Carefully read the sections marked with this symbol for disposing of the appliance.

PURPOSE AND CONTENT OF THE MANUAL

The aim of this manual is to provide customers with all the information needed to use the machine in the safest, most appropriate and most autonomous way. This includes information concerning technical aspects, safety, operation, downtime, maintenance, spare parts and scrapping. The operators and qualified technicians must carefully read the instructions in this manual before carrying out any operations on the machine. If in doubt about the correct interpretation of instructions, contact your nearest Comac Customer Service Centre to obtain the necessary clarifications.

TARGET GROUP

This manual is written both for operators and for qualified machine maintenance technicians. Operators must not perform operations that should be carried out by qualified technicians. The manufacturer is not liable for damages resulting from failure to comply with this veto.

PRESERVATION OF THE USER

The Use and Maintenance Manual must be stored in its special pouch close to the machine, protected from liquids and anything else that could compromise its legibility.

ON CONSIGNMENT OF THE MACHINE

When the machine is consigned to the customer, an immediate check must be performed to ensure all the material mentioned in the shipping documents has been received, and also to check the machine has not suffered damage during transportation. If this is the case, the carrier must ascertain the extent of the damage at once, informing our customer service office. It is only by prompt action of this type that the missing material can be obtained, and compensation for damage successfully claimed.

INTRODUCTORY COMMENT

Any floor scrubbing machine can only work properly and effectively if used correctly and kept in full working order by performing the maintenance operations described in the attached documentation. We therefore suggest you read this instruction booklet carefully and read it again whenever difficulties arise while using the machine. If necessary, remember that our assistance service (organised in collaboration with our dealers) is always available for advice or direct intervention.

IDENTIFICATION DATA

For technical assistance or to request replacement parts, always give the model, the version and the serial number (written on the relevant plate).

TECHNICAL DESCRIPTION

The **Vispa Evo Essential** and the **Vispa XL Essential** are floor scrubbing machines that can handle a wide variety of floors and types of dirt using the mechanical action of a brush or an abrasive pad and the chemical action of a water-detergent solution. As they advance, they collect the dirt removed and the detergent solution not absorbed by the floor. **The machine must only be used for this purpose.**

INTENDED USE

This scrubbing machine was designed and built for the cleaning (scrubbing and drying) of smooth, compact flooring in the commercial, residential and industrial sectors by a qualified operator in proven safety conditions. The scrubbing machine is not suitable for cleaning rugs or carpet floors. It is only suitable for use in closed (or at least covered) places.

 **ATTENTION:** the machine is not suitable for use in the rain, or under water jets.

 **IT IS FORBIDDEN** to use the machine in environments with an explosive atmosphere to clean dangerous powders or flammable liquids. In addition, it is not suitable as a means of transport for people or objects.

SAFETY

Operator cooperation is paramount for accident prevention. No accident prevention programme can be effective without the full cooperation of the person directly responsible for machine operation. The majority of occupational accidents that happen either in the workplace or whilst moving are caused by failure to respect the most basic safety rules. An attentive, careful operator is most effective guarantee against accidents and is fundamental in order to implement any prevention programme.

REGULATIONS

All references to forwards and backwards, front and rear, right and left indicated in this manual should be understood as referring to the operator in the driving position, with his/her hands on the control column.

SERIAL NUMBER PLATE

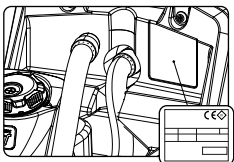

The serial number plate is located inside the solution tank, and indicates the general characteristics of the machine, in particular the serial number of the machine. The serial number is a very important piece of information and should always be provided together with any request for assistance or when purchasing spare parts. The serial number plate contains the following:

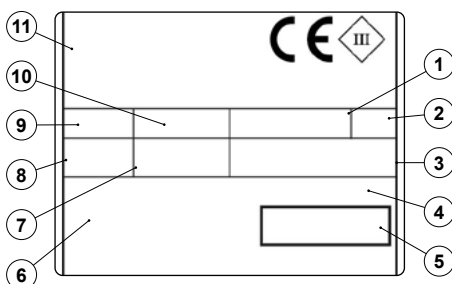

1. The weight of the batteries that power the machine (expressed in kg).
2. The IP protection rating of the machine.
3. The gross weight of the machine (expressed in kg).
4. The machine ID code.
5. The machine serial number.
6. The machine ID name.
7. The nominal power consumed by the machine (expressed in W).
8. The maximum grade that the appliance can handle during work activities (expressed in %).
9. The year of machine manufacture.
10. The nominal voltage of the machine (expressed in V).
11. The commercial name of the machine, and the manufacturer's address.

TECHNICAL DATA

TECHNICAL DATA	U/M [KMS]	Vispa Evo	Vispa XL	Vispa XL Orbital
Nominal input power [IEC 60335-2-72; IEC 62885-9]	kW	0,72	0,78	0,68
Productivity theoretical	m ² /h	1300	1600	1600
Working width [IEC 62885-9]	mm	355	430	430
Total width of brushes [IEC 62885-9]	mm	1x355	1x432	-
Total width of the abrasive pad [IEC 62885-9]	mm	-	-	1x432
Nominal power of brush motor/s [IEC 62885-9]	W	440	500	400
Single brush rpm	rpm	197	140	-
Number of oscillations of the abrasive pad	rpm	-	-	2300
Maximum pressure exerted by the brush head on the floor	N/cm ²	0,42	0,55	0,55
Maximum gradeability during work (GVW)	%	2	2	2
Drying track [IEC 62885-9]	mm	420	510	510
Squeegee width	mm	440	516	516
Nominal power of vacuum motor(s) [IEC 62885-9]	W	280	280	280
Maximum vacuum [IEC 62885-9; IEC 60312-1]	KPa	6,9	6,8	6,8
Solution tank	l	15	25	25
Recovery tank	l	17	27	27
Machine dimensions during transport [IEC 62885-9]	mm	457	490	490
Machine dimensions (length - height - width)	mm	765 1110 490	895 1215 530	895 1215 530
Battery compartment dimensions (length - height - width)	mm	215 195 270	245 250 290	245 250 290
Machine net weight [IEC 62885-9]	kg	52,5	68	68
Machine weight during transport [IEC 62885-9]	kg	73,5	105	105
GVW [IEC 60335-2-72; IEC 62885-9]	kg	84	130	130
Sound pressure level in operator seat [ISO 11201] (L _{pA})	dB	61,4	<70	<70
Sound power level [IEC 60335-2-72; IEC 62885-9; ISO 3744] (L _{WA})	dB	73,9	<80	<80
Uncertainty K _{pA}	dB	±1,5	±1,5	±1,5
Hand-arm vibrations [IEC 60335-2-72; IEC 62885-9; ISO 5349-1]	m/s ²	0,48	0,77	0,77
Vibration measurement uncertainty		±4%	±4%	±4%
IP test [IEC 60335-2-72; IEC 60529]		IP 23	IP 23	IP 23

SYMBOLS AND LABELS USED ON THE MACHINE

SYMBOLS USED ON THE MACHINE



Filter body position symbol:

Applied to the front of the machine to indicate the position of the solution tank filter.



Recovery tank drainage hose symbol:

Applied to the left-hand side of the machine to identify where to insert the dumping system tube for the solution tank.



Symbol for maximum temperature for filling the solution tank:

Located on the front of the machine to indicate the maximum temperature of the water for filling the solution tank safely.

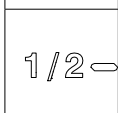

Solution tank filling symbol:

Located on the left side of the machine's solution tank to indicate the amount of water or detergent solution in the tank. The symbol on the side indicates that the tank is full to about a half of its capacity.



Solution tank filling symbol:

Located on the left side of the machine's solution tank to indicate the amount of water or detergent solution in the tank. The symbol on the side indicates that the tank is full.

LABELS USED ON THE MACHINE



Label indicating the need to read the Use and Maintenance Manual:

Applied in the vicinity of the steering column in order to remind the operator to read the user and maintenance manual before using the machine.



Label indicating the need to read the Use and Maintenance Manual:

Used in the brush head body, and indicates the prohibition to approach the brush head while the brush is moving.



Usage warning label:

Used on the back of the machine. The label indicates the absolute prohibition to vacuum and/or collect waste in a solid and/or liquid state that is incandescent and/or flammable and/or explosive.



Battery gas emissions warning label:

Used on the back of the machine. The label indicates that while the battery is charging, highly flammable hydrogen vapours could escape. The label indicates that before performing maintenance on the machine, disconnect battery power supply cable from the machine's main cable. The label indicates that it is prohibited to charge the batteries if the battery charger power supply cable is damaged.



Battery charging phase label:

Used on the back of the machine. The label indicates the phases to perform to charge the batteries (valid for versions without CB).



Machine starting instructions label:

Used on the back of the control column. The label indicates the phases for starting the machine for operation.

CONTROL PANEL

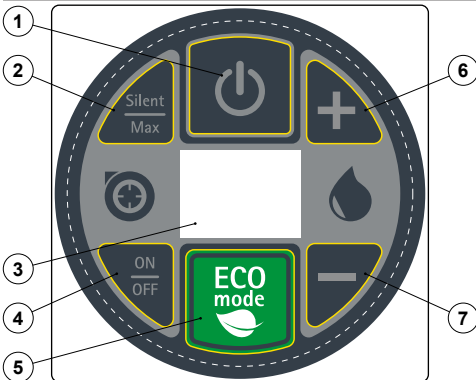

The control panel is divided as follows:

1. Machine stand-by mode activation - deactivation button.
2. SILENT - MAX function activation - deactivation button.
3. Control display.
4. Suction motor activation or deactivation button.
5. Eco mode program activation or deactivation button.
6. Button to increase the level increment of detergent solution on the brush.
7. Button to decrease the level increment of detergent solution on the brush.

CONTROL DISPLAY

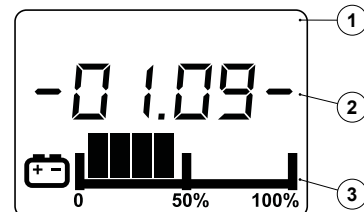

The control display is divided in:

1. Symbol string.
2. Text string.
3. Battery charge level.

PREPARATION OF MACHINE

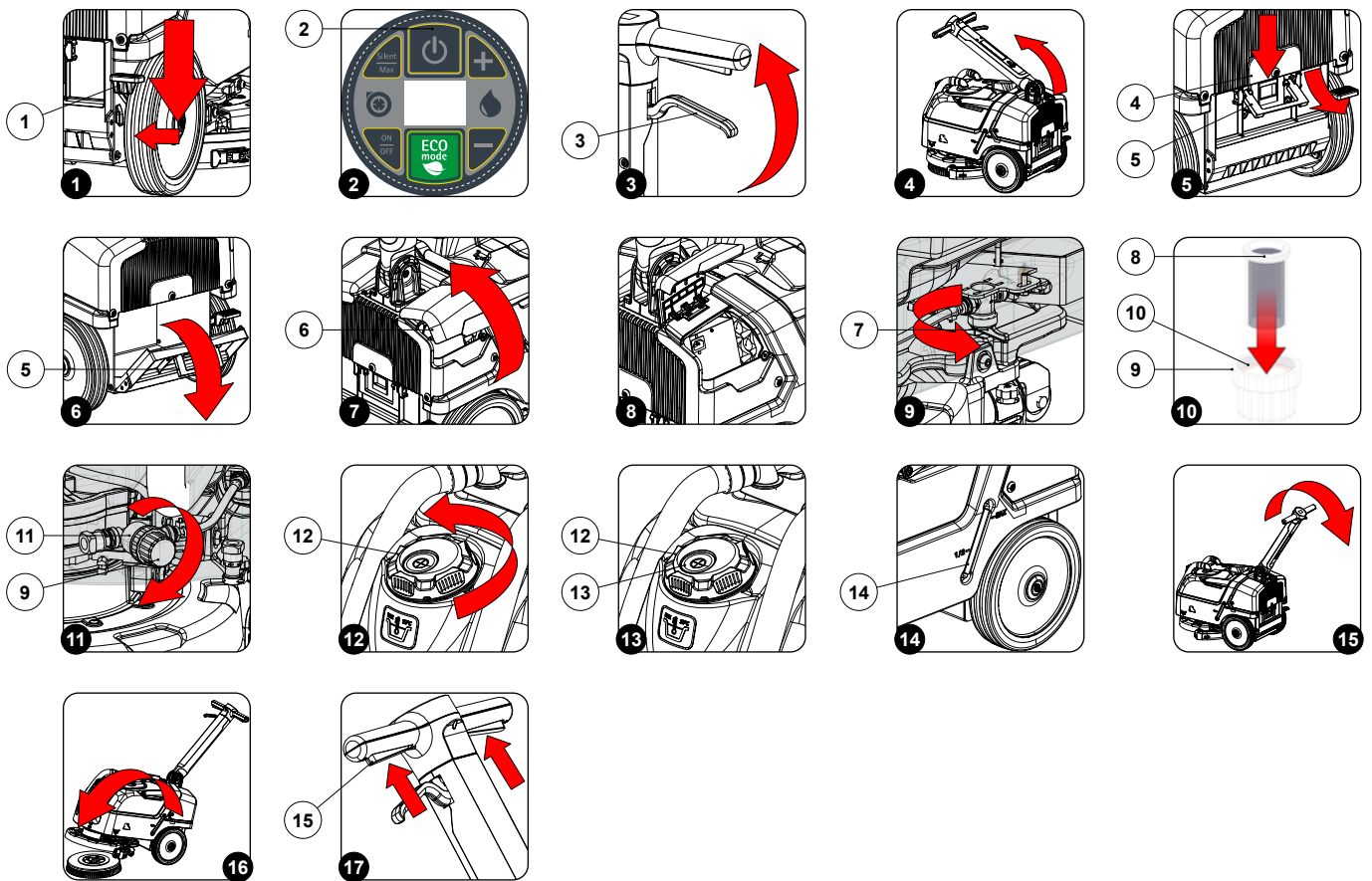

HANDLING THE PACKAGED MACHINE

The machine's overall weight including packaging is 65kg for the Evo or 00Kg for the XL.

The external dimensions of the package are:

- width 58cm; length 88cm and height 76cm for the Evo.
- width 66cm; length 100cm and height 86cm for the XL.

i **N.B.:** it is recommended that all the packaging components be kept for any future machine transportation.

⚠ **DANGER:** Move the packaged product with handling equipment that complies with legal requirements regarding size and mass of the packaging.

HOW TO UNPACK THE MACHINE

The machine is shipped in specific packaging. To remove it, proceed as follows:

1. Place the lower part of the outer packaging in contact with the floor.

i **N.B.:** use the pictograms printed on the box as a reference.

2. Remove the outer package.

⚠ **WARNING:** the machine is contained in specific packaging materials, whose elements (plastic bags, staples, etc.) can pose potential hazards, and must not be left within reach of children, disabled persons, etc.

👤 **ATTENTION:** It is recommended to wear the appropriate PPE (Personal Protective Equipment), suitable for the work to be carried out.

3. Insert a ramp in the rear part of the machine.

⚠ **ATTENTION:** the ramp gradient must not be such as to cause damage to the machine as it comes down.

4. The machine is secured to the footboard with wedges that lock the wheels, remove these wedges.
5. Drive the machine down the ramp.

⚠ **ATTENTION:** during this operation, check there are no people or objects near the machine.

HOW TO MOVE THE MACHINE

To transport the machine safely, proceed as follows:

 **DANGER:** before starting any task, make sure the current regulations concerning the safe transport of dangerous substances are scrupulously observed.

1. Check that the solution tank and the recovery tank are empty; if this is not the case, empty them (see paragraphs "DRAINING THE RECOVERY TANK" on page 21 and "EMPTYING THE SOLUTION TANK" on page 22).
2. Stand at the back of the machine.
3. Lift the squeegee body, press the "SQUEEGEE CONTROL" pedal (1) at the rear right of the machine (**Fig.1**).
4. Use a ramp to move the machine up onto the transport vehicle.

 **ATTENTION:** during this operation, check there are no people or objects near the machine.

 **N.B.:** the ramp gradient must not be such as to cause damage to the machine as it goes up.

5. Place the machine on the transport device, put the machine in stand-by by pressing the button (2) located on the control panel (**Fig.2**).
6. Press the uncoupling lever (3) (**Fig.3**) and turn the control column to the vertical position (**Fig.4**).
7. Press the uncoupling lever (4) (**Fig.5**) and open the battery compartment closing carter, using the handle (5) (**Fig.6**).
8. Disconnect the electrical connector from the machine's general system.
9. Reclose the battery compartment closure carter, make sure that the retainer system is correctly engaged.

 **WARNING:** secure the device according to the directives in force in the country of use, so that it cannot slide or tip over.

MACHINE SAFETY

To ensure that work is carried out in the best safety conditions, proceed as follows:

1. Check that the solution tank and the recovery tank are empty; if this is not the case, empty them (see paragraphs "DRAINING THE RECOVERY TANK" on page 21 and "EMPTYING THE SOLUTION TANK" on page 22).
2. Stand at the back of the machine.
3. Lift the squeegee body, press the "SQUEEGEE CONTROL" pedal (1) at the rear right of the machine (**Fig.1**).
4. Put the machine in stand-by by pressing the button (2) located on the control panel (**Fig.2**).
5. Press the uncoupling lever (4) (**Fig.5**) and open the battery compartment closing carter, using the handle (5) (**Fig.6**).
6. Disconnect the electrical connector from the machine's general system.
7. Reclose the battery compartment closure carter, make sure that the retainer system is correctly engaged.

TYPE OF BATTERY TO BE USED (Evo versions)

CODE	DESCRIPTION
229862	BATTERY KIT 12V 33Ah AGM
229891	BATTERY KIT 12V 26Ah Pb
229863	BATTERY KIT 12V 36Ah Pb

Used batteries must meet the requirements set out in DIN EN 50272-3 "Traction batteries for industrial trucks".

To ensure proper performance, the machine must be powered with 24V.
The machine can be powered with the battery kits listed in the table to the side.

 **N.B.:** it is recommended to use battery kit 12V 33Ah AGM.

TYPE OF BATTERY TO BE USED (XL versions)

CODE	DESCRIPTION
229890	BATTERY KIT 12V 55Ah AGM
229863	BATTERY KIT 12V 36Ah Pb
229950	BATTERY KIT 12V 61Ah Pb

Used batteries must meet the requirements set out in DIN EN 50272-3 "Traction batteries for industrial trucks".

To ensure proper performance, the machine must be powered with 24V.
The machine can be powered with the battery kits listed in the table to the side.

 **N.B.:** it is recommended to use battery kit 12V 55Ah AGM.

BATTERY MAINTENANCE AND DISPOSAL

For battery maintenance and recharging, respect the instructions provided by the battery manufacturer. When the batteries reach the end of their service life, they must be disconnected by a specialised and properly trained operator, and must be subsequently removed from the battery compartment using suitable lifting devices.

 **N.B.:** dead batteries are classified as dangerous waste and as such must be delivered to an authorised body for disposal.

INSERTING THE BATTERIES INTO THE MACHINE

The batteries must be housed in the special compartment at the rear of the machine and should be handled using lifting equipment that is suitable in terms of both weight and its coupling system.

 **ATTENTION:** It is recommended to wear the appropriate PPE (Personal Protective Equipment), suitable for the work to be carried out.

 **ATTENTION:** to prevent an accidental short circuit use insulated tools to connect the batteries, and do not place or drop metal objects on the battery. Remove rings, watches and any clothing with metal parts that may come into contact with the battery terminals.

The various phases for inserting the batteries in the battery compartment are as follows:

1. Carry out the steps necessary to secure the machine (see paragraph "MACHINE SAFETY" on page 11).
2. Move to the rear of the machine, press the uncoupling lever (4) (**Fig.5**) and open the battery compartment closing carter, using the handle (5) (**Fig.6**).

 **N.B.:** for battery maintenance and daily recharging, you must fully respect the indications provided by the manufacturer or retailer.

 **ATTENTION:** all installation and maintenance operations must be carried out by specialised personnel.

 **N.B.:** before installing the battery, clean the battery compartment.

 **N.B.:** Check that the connectors on the cables supplied are functioning correctly.

 **ATTENTION:** check that the characteristics of the battery that you are looking to use are appropriate for the type of work to be performed.

 **ATTENTION:** Check the battery charge and the condition of the contacts on the battery.

 **N.B.:** you are advised to only lift and move the batteries with lifting and transportation means suitable for the specific weight and size

 **ATTENTION:** the lifting hooks must not damage the blocks, connectors or cables.

 **N.B.:** Before inserting the batteries into the machine, remember to cover the terminals with a little grease to protect them against external corrosion.

3. House the batteries in the compartment, positioning the poles "+" and "-" opposite each other.

 **ATTENTION:** The battery compartment cover acts as a support surface when it is in a horizontal position, and the handle (5) acts as a reinforcement and therefore must be positioned perpendicularly to the floor.

CONNECTING THE BATTERIES TO THE MACHINE'S ELECTRICAL SYSTEM

 **N.B.:** The batteries should be connected so as to obtain a total voltage of 24V.

 **ATTENTION:** It is recommended that the electrical connection operations be carried out by specialised and trained personnel.

 **ATTENTION:** to prevent an accidental short circuit use insulated tools to connect the batteries, and do not place or drop metal objects on the battery. Remove rings, watches and any clothing with metal parts that may come into contact with the battery terminals.

The various phases for inserting the batteries in the battery compartment are as follows:

1. Using the supplied jumper cable, connect the batteries to the "+" and "-" poles in series.
2. Connect the battery connector cable to the "+" and "-" poles in order to obtain the terminal voltage of 24V.
3. Connect the battery connector to the electrical system connector.

RECHARGING THE BATTERIES

The batteries must be charged prior to first use, and whenever they no longer provide sufficient power to perform the desired work.

 **ATTENTION:** The control board and the battery charger, if present on-board, are set for AGM batteries, contact the nearest Comac service centre to modify the setting if you want to use another type of battery.

 **ATTENTION:** to avoid any permanent damage to the batteries, it is essential to avoid their complete discharge; begin recharging them within a few minutes of noting the "discharged batteries" signal.

 **ATTENTION:** Never leave the batteries completely discharged, even if the machine is not being used.

1. Bring the machine to the battery recharging area.

 **ATTENTION:** park the machine in an enclosed place, on a flat and level surface; near the machine there must be no objects that could either damage it, or be damaged through contact with it.

 **DANGER:** the room used to recharge the batteries must be adequately ventilated to prevent the accumulation of gases that leak from batteries.

2. Carry out the steps necessary to secure the machine (see paragraph "MACHINE SAFETY" on page 11).

To recharge the batteries without the built-in battery charger, proceed as follows:

 **ATTENTION:** the following operations must be carried out by qualified personnel. An incorrect connection of the connector may cause a malfunction of the device.

3. Press the uncoupling lever (4) (**Fig.5**) and open the battery compartment closing carter, using the handle (5) (**Fig.6**).
- Disconnect the battery connector from the electric system connector.
 - Connect the external battery charger cable to the battery connector.

 **N.B.:** the coupling connector of the battery charger is consigned inside the bag containing this instruction booklet, and must be assembled on the cables of the battery charger as indicated in the instructions.

 **DANGER:** before connecting the batteries to the battery charger, make sure it is suitable for the batteries used.

 **N.B.:** carefully read the use and maintenance instructions of the battery charger that is used for charging.

 **ATTENTION:** Keep the battery compartment closing carter open for the entire duration of the battery recharging cycle to allow gas fumes to escape.

- Once the recharge cycle has been completed, disconnect the battery charger's cable from the battery connector.
- Connect the battery connector to the electrical system connector.
- Reclose the battery compartment closure carter, make sure that the retainer system is correctly engaged.

To recharge the batteries with the on-board battery charger proceed as follows:

 **ATTENTION:** the following operations must be carried out by qualified personnel. An incorrect connection of the connector may cause a malfunction of the device.

 **N.B.:** Carefully read the use and maintenance instructions of the battery charger that is used for charging, this document is delivered along with the machine.

- Press the uncoupling lever (4) (**Fig.5**) and open the battery compartment closing carter, using the handle (5) (**Fig.6**).
- Turn the battery charge cover (6) as far as possible (**Fig.7**).
- Remove the cap that covers the battery charger socket (**Fig. 8**).

 **ATTENTION:** before connecting the batteries to the battery charger, make sure it is suitable for the batteries used.

 **WARNING:** Before inserting the battery charger power cable into the socket, verify that there is no condensate or other forms of liquids.

 **N.B.:** the battery charger power cable is delivered inside the bag containing this instruction booklet.

- Plug the battery charger cable into the mains socket.
- Connect the battery charger's power cable to the socket on the battery charger itself.

 **ATTENTION:** keep the recovery tank open for the duration of the battery recharging cycle to allow gas fumes to escape.

- When the recharge cycle is complete, disconnect the battery charger cable from the mains.
- Disconnect the battery charger's power cable from the socket on the battery charger itself.
- Reposition the cap in the battery charger socket.
- Reclose the battery charging cover, make sure that the retainer system is correctly engaged.
- Reclose the battery compartment closure carter, make sure that the retainer system is correctly engaged.

INSERTING WATER SYSTEM FILTER

Before using the machine for the first time the water system filter needs to be reset, for shipping reasons the filter cartridge and the cap have been removed. To insert the filter cartridge in the water system filter body proceed as follows:

1. Take the machine to the maintenance area.
2. Carry out the steps necessary to secure the machine (see paragraph "MACHINE SAFETY" on page 11).



ATTENTION: It is recommended to wear the appropriate PPE (Personal Protective Equipment), suitable for the work to be carried out.

3. Move to the front left of the machine and tighten the tap outflow, turn the lever (7) located in the tap body clockwise (**Fig.9**).
4. Insert the filter cartridge (8) in the housing on the cap (9) (**Fig.10**).



N.B.: The o-ring gasket (10) in the filter cartridge must be inserted into its seat in the cap (**Fig.10**).

5. Screw the cap (9) onto the body of the filter (11) (**Fig.11**).

FILLING THE SOLUTION TANK

Before filling the solution tank, carry out the following steps:

1. Take the machine to the usual place for filling the solution tank.
2. Carry out the steps necessary to secure the machine (see paragraph "MACHINE SAFETY" on page 11).
3. Move to the front of the machine and check that the water system filter cap (9) is tightened, otherwise tighten it (**Fig.11**).

The solution tank can be filled with water in two different ways:

- Removing the cap/measuring device (12) and filling the solution tank by means of a rubber hose or a bucket (**Fig.12**).
 - Inserting the filling tube in the hole (13) located in the cap/measuring device (12) (**Fig.13**), the hole is able to support the filling tube by itself.
4. Fill with clean water, at a temperature no higher than 50°C (122°F) and no lower than 10°C (50°F). The amount inside the tank can be seen by means of the level tube (14) on the left-hand side of the machine (**Fig.14**).

DETERGENT SOLUTION

After filling the solution tank with clean water, add the liquid detergent to the tank in the concentration and manner indicated on the detergent manufacturer's label.

To prevent the formation of an excessive amount of foam that could damage the vacuum motor, use the minimum percentage of detergent required.



ATTENTION: It is recommended to wear the appropriate PPE (Personal Protective Equipment), suitable for the work to be carried out.



ATTENTION: always use detergents whose manufacturer's label indicates their suitability for scrubbing machines. Do not use acid or alkaline products or solvents without this indication.



ATTENTION: always use low-foam detergent. To avoid the production of foam, put a minimum quantity of antifoam liquid in the recovery tank before starting to clean. Do not use pure acids.

ASSEMBLING THE BRUSH HEAD BRUSH (SCRUBBING VERSION)

To fit the brush on the brush head body, proceed as follows:

1. Release the control column from the vertical position, press the stop lever (3) (**Fig.3**) and turn the control column towards yourself (**Fig.15**).
2. Turn the column towards yourself to find the optimal position, this position must provide a sensation of comfort when using the machine. Once the ideal position has been found, release the stop lever (2) to lock the column.
3. Place the brush on the floor and place the brush head body over it (**Fig.16**).
4. Activate the machine by pressing the button (2) located on the control panel (**Fig.2**).
5. Press the operator presence lever (15) (**Fig.17**), the gearmotor will activate and the brush will be connected to the brush retainer plate.



ATTENTION: during this operation, check there are no people or objects near the machine.

ASSEMBLING THE ABRASIVE PAD (ORBITAL VERSION)

To fit the brush on the brush head body, proceed as follows:

1. Release the control column from the vertical position, press the stop lever (3) (**Fig.3**) and turn the control column towards yourself (**Fig.15**).
2. Turn the column towards yourself to find the optimal position, this position must provide a sensation of comfort when using the machine. Once the ideal position has been found, release the stop lever (2) to lock the column.
3. Position the abrasive pad on the floor and place the brush head body on top of it.

PREPARING TO WORK

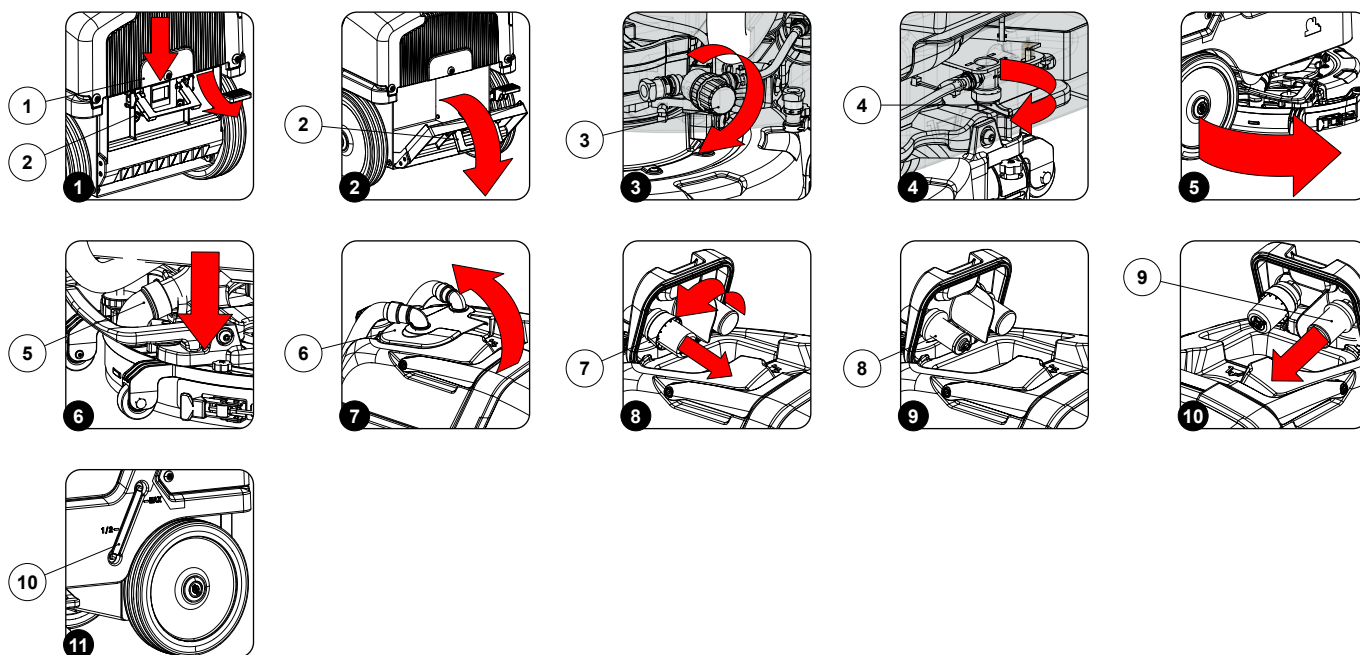

Before beginning to work, it is necessary to:

1. Move to the rear of the machine, press the uncoupling lever (1) (Fig.1) and open the battery compartment closing carter, using the handle (2) (Fig.2).

⚠ ATTENTION: the following operations must be carried out by qualified personnel. An incorrect connection of the connector may cause a malfunction of the device.

2. Connect the battery connector to the electrical system connector.
3. Reclose the battery compartment closure carter, make sure that the retainer system is correctly engaged.
4. Move to the front left of the machine and check that the water system filter cap (3) is closed, otherwise tighten it (Fig.3).
5. Move to the front left of the machine and check that the water tap is opened completely, turn the lever (4) clockwise (Fig.4).
6. Move to the front right of the machine and turn the squeegee support counter-clockwise (Fig.5).
7. Make sure the vacuum tube (5) is correctly connected to the sleeve on the squeegee body. If it isn't, connect it (Fig.6).
8. Remove the recovery tank cover (6) (Fig.7).
9. Make sure the recovery tank is empty; if not, empty it completely (see paragraph. "DRAINING THE RECOVERY TANK" on page 21).
10. Remove the floating guard (7) by turning it clockwise (Fig.8).
11. Check that the suction motor (8) is correctly connected and cleaned (Fig.9); if this is not the case, clean it (see paragraph "CLEANING THE RECOVERY TANK FILTERS" on page 22).
12. Check that the squeegee filter (9) is correctly connected and cleaned (Fig.10); if this is not the case, clean it (see paragraph "CLEANING THE RECOVERY TANK FILTERS" on page 22).
13. Refit the recovery tank cover.
14. Check that the quantity of detergent solution in the solution tank is correct for the type of work to be carried out; if not, refill the solution tank (see paragraphs "FILLING THE SOLUTION TANK" on page 14 and "DETERGENT SOLUTION" on page 14).

i N.B.: The amount inside the tank can be seen by means of the level tube (10) on the left-hand side of the machine (Fig.11).

15. Check that the squeegee rubber blades are in a suitable condition for performing the work; if this is not the case, carry out the appropriate maintenance (see paragraph "REPLACING THE SQUEEGEE BODY RUBBER BLADES" on page 24).
16. Check the condition of the brush; in case of excessive wear, carry out the appropriate maintenance (see paragraph "REPLACING THE BRUSH HEAD BRUSH (SCRUBBING VERSION)" on page 24).

i N.B.: The condition of wear of the brushes can be inspected by checking if the bristles are longer than 10mm, otherwise they must be replaced (the brush has a tuft of yellow bristles, the total height of the tuft is 10mm).

STARTING WORK

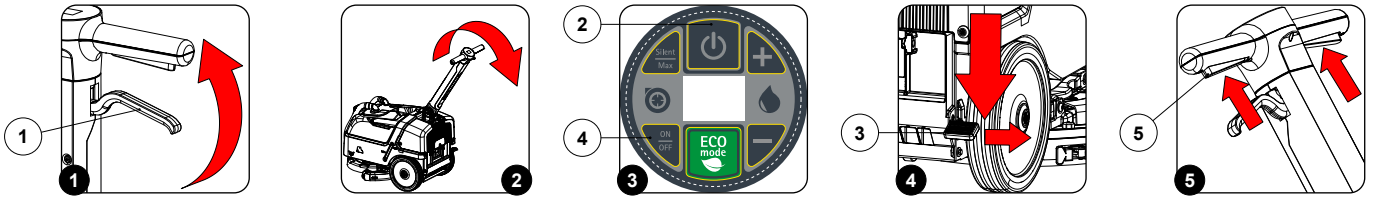

The machine can be used in the following work modes:

- ECO MODE, see paragraph "ECO MODE" on page 18.
- MANUAL MODE, see paragraph "MANUAL MODE" on page 18.

The working program "SCRUBBING WITH DRYING" in "ECO MODE" will be taken as an example. To start working in this mode, proceed as follows:

1. Carry out all the checks listed in the chapter "PREPARING TO WORK" on page 15.
2. Sit on the driver's seat.
1. Release the control column from the vertical position, press the stop lever (1) (Fig.1) and turn the control column towards yourself (Fig.2).
2. Turn the column towards yourself to find the optimal position, this position must provide a sensation of comfort when using the machine. Once the ideal position has been found, release the stop lever (1) to lock the column.
3. Activate the machine by pressing the button (2) located on the control panel (Fig.3).
4. Lower the squeegee, activate the pedal (3) located at the rear right of the machine (Fig.4).
5. Activate the suction motor by pressing the button (4) located on the control panel (Fig.3).
6. Press the operator presence lever (5) (Fig.5).
7. As soon as the operator presence levers are pressed, the brush head motor and the suction motor will start working. As a result, also the pump in the water system will start to operate and detergent solution will be delivered to the brush. During the first few metres, check that there is sufficient solution and that the squeegee is drying correctly.
8. The machine will now begin to work with full efficiency until the battery is flat or until the detergent solution has finished.

HOUR METER

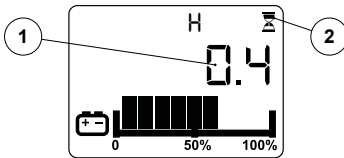

The machine control panel contains the control display, which shows the total usage time via a series of numbers (1). The digits that precede the "." symbol identify the hours, whereas the numbers that precede the "." symbol identify the tenths of an hour (a tenth of an hour corresponds to six minutes).

i **N.B.:** When the "hour glass" symbol (2) is flashing it indicates that the hour meter is counting the appliance's operating time.

BATTERY CHARGE LEVEL INDICATOR

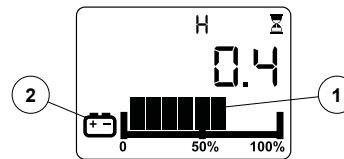

The control display is on the control panel, the battery charge level can be seen at the bottom. The indicator is composed of two charge level symbols, the first represented by a graphic symbol (1), the second by a symbol that represents a battery (2).

The graphic symbol (1) is composed of 9 charge levels, each of which represents a residual charge percentage.

When the residual charge is at 20% the battery symbol (2) starts to flash, in these conditions bring the machine to the area used for charging the batteries.

i **N.B.:** a few seconds after the battery charge level reaches 20%, the brush motor switches off automatically. With the remaining charge it is still possible, however, to complete the drying process before recharging

i **N.B.:** a few seconds after the battery charge level reaches 10%, the suction motor switches off automatically. With the remaining charge, it is still possible, however, to move the machine to the location designated for its recharging.

OVERFLOW DEVICE

The standard model machine is NOT equipped with an overflow device, because the volume of the recovery tank is larger than the capacity of the solution tank. In extraordinary cases, there is a mechanical device (float) under the recovery tank lid that, when the recovery tank is full, shuts off the air to the vacuum motor intake to protect it; the sound of the suction motor will then be deeper. Empty the recovery tank (see paragraph "DRAINING THE RECOVERY TANK" on page 21).

WORKING PROGRAMS

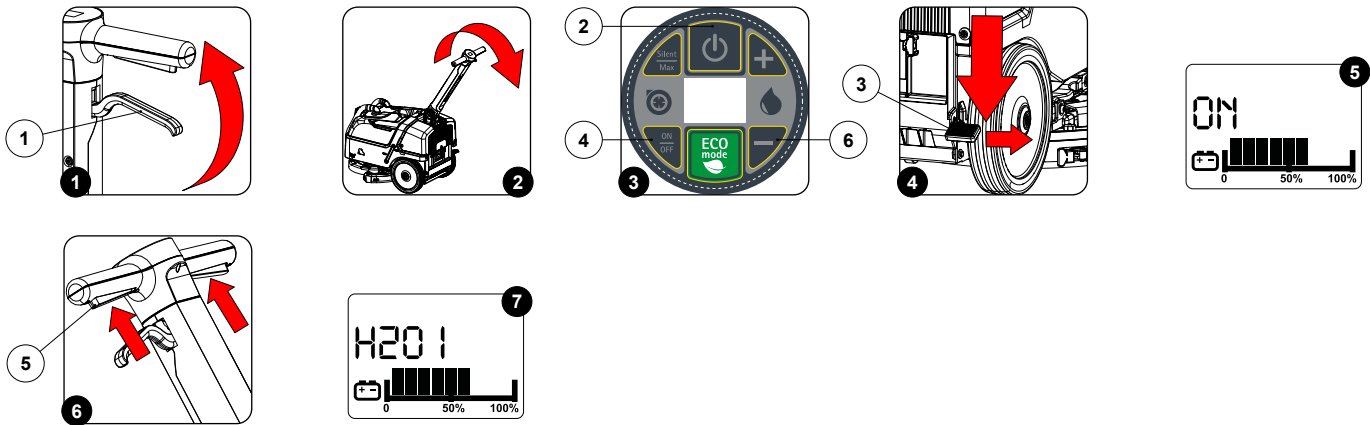

SCRUBBING WITH DRYING

To perform a scrubbing and drying program, proceed as follows:

1. Carry out all the checks listed in the chapter "PREPARING TO WORK" on page 15.
2. Sit on the driver's seat.
1. Release the control column from the vertical position, press the stop lever (1) (**Fig.1**) and turn the control column towards yourself (**Fig.2**).
2. Turn the column towards yourself to find the optimal position, this position must provide a sensation of comfort when using the machine. Once the ideal position has been found, release the stop lever (1) to lock the column.
3. Activate the machine by pressing the button (2) located on the control panel (**Fig.3**).
4. Lower the squeegee, activate the pedal (3) located at the rear right of the machine (**Fig.4**).
5. Activate the suction motor by pressing the button (4) located on the control panel (**Fig.3**).

i N.B.: As soon as the button (4) is pressed, "ON" will appear on the control display (**Fig.5**).

6. Press the operator presence lever (5) (**Fig.6**).
7. As soon as the operator presence levers are pressed, the brush head motor and the suction motor will start working. As a result, also the pump in the water system will start to operate and detergent solution will be delivered to the brush. During the first few metres, check that there is sufficient solution and that the squeegee is drying correctly.
8. The machine will now begin to work with full efficiency until the battery is flat or until the detergent solution has finished.

SCRUBBING WITHOUT DRYING

To perform a scrubbing program without drying, proceed as follows:

1. Carry out all the checks listed in the chapter "PREPARING TO WORK" on page 15.
2. Sit on the driver's seat.
1. Release the control column from the vertical position, press the stop lever (1) (**Fig.1**) and turn the control column towards yourself (**Fig.2**).
2. Turn the column towards yourself to find the optimal position, this position must provide a sensation of comfort when using the machine. Once the ideal position has been found, release the stop lever (1) to lock the column.
3. Activate the machine by pressing the button (2) located on the control panel (**Fig.3**).
4. Press the operator presence lever (5) (**Fig.6**).
5. As soon as the operator presence levers are pressed, the brush head motor and the suction motor will start working. As a result, also the pump in the water system will start to operate and detergent solution will be delivered to the brush. During the first few metres, check that there is sufficient solution.
6. The machine will now begin to work with full efficiency until the battery is flat or until the detergent solution has finished.

DRYING WITHOUT SCRUBBING

To perform a working program of only drying without scrubbing the floor, proceed as follows:

1. Carry out all the checks listed in the chapter "PREPARING TO WORK" on page 15.
2. Sit on the driver's seat.
1. Release the control column from the vertical position, press the stop lever (1) (**Fig.1**) and turn the control column towards yourself (**Fig.2**).
2. Turn the column towards yourself to find the optimal position, this position must provide a sensation of comfort when using the machine. Once the ideal position has been found, release the stop lever (1) to lock the column.
3. Activate the machine by pressing the button (2) located on the control panel (**Fig.3**).
4. Adjust the detergent solution delivery level to "H2O 0", press the button "-" repeatedly (6) (**Fig.3**) until "H2O 0" appears on the control display.

i **N.B.:** The first time one of the two symbols shown above in the control display are pressed, the current level of detergent solution will be shown for two seconds (**Fig.7**).

5. Lower the squeegee, activate the pedal (3) located at the rear right of the machine (**Fig.4**).
6. Activate the suction motor by pressing the button (4) located on the control panel (**Fig.3**).

i **N.B.:** As soon as the button (4) is pressed, "ON" will appear on the control display (**Fig.5**).

7. Press the operator presence lever (5) (**Fig.5**).
8. As soon as the operator presence levers are pressed, the brush head motor and the suction motor will start working, the pump in the water system will not start to deliver detergent solution to the brush. During the first few metres of work, check that the squeegee is frying properly.
9. The machine will now work at its maximum efficiency level.



ATTENTION: The drying without scrubbing operation should only be carried out if the device was used beforehand to carry out a scrubbing without drying operation.

ADDITIONAL FUNCTIONS



ECO MODE

At the centre of the control panel is the ECO MODE button; pressing this will activate "ECO MODE", a program which guarantees the best possible performance in terms of consumption and cleaning.

To activate the ECO MODE program with the machine stopped and active, press the button (1) in the centre of the control panel (**Fig.1**).

i **N.B.:** As soon as the button (1) is pressed, "ECO" will appear on the control display (**Fig.2**).

i **N.B.:** As soon as the machine is activated by pressing the button (2) located on the control panel (**Fig.1**), ECO MODE will be automatically loaded.

i **N.B.:** To deactivate ECO MODE, press the button (1) in the centre of the control panel (**Fig.1**). As soon as the button (1) is pressed, "ECO" will disappear from the control display (**Fig.3**).

i **N.B.:** ECO MODE can also be deactivated by pressing one of the buttons (3) (**Fig.1**) used to adjust the supply of detergent solution to the brush (see paragraph "ADJUSTMENT OF THE DETERGENT SOLUTION FLOW" on page 19).

i **N.B.:** ECO MODE can also be deactivated by pressing the "SILENT/MAX" button (4) (**Fig.1**), which is used to adjust the suction motor performance (see paragraph "SILENT-MAX FUNCTION" on page 19).

MANUAL MODE

To change from "ECO MODE" to "MANUAL MODE", simply change one of the following parameters:





1. Adjust the quantity of detergent solution present in the machine water system using the buttons (3) on the control panel (**Fig.1**) (see paragraph "ADJUSTMENT OF THE DETERGENT SOLUTION FLOW" on page 19).
2. Adjust the performance level of the suction motor by using the button (4) on the control panel (**Fig.1**) (see paragraph "SILENT-MAX FUNCTION" on page 19).

i **N.B.:** When "MANUAL MODE" is active in the control display, "ECO" will disappear from the control display (**Fig.2**).

ADJUSTMENT OF THE DETERGENT SOLUTION FLOW



To adjust the flow of detergent solution during work, proceed as follows:

1. During the first few working meters check that the amount of solution is sufficient to wet the floor, but not enough to be collected by the squeegee.
2. If the amount of solution that comes out is not right, use the "+" and "-" buttons (3) on the control panel to adjust it (**Fig.1**).

-  **N.B.:** The detergent solution flow regulation function is only active when the gearmotor in the brush head body is active.
-  **N.B.:** The first time one of the two symbols shown above in the control display are pressed, the current level of detergent solution will be shown for two seconds (**Fig.3**).
-  **N.B.:** The flow of detergent solution onto the brush can be adjusted to four levels, from "H2O 0" to a maximum of "H2O 3". The level can be seen by the text on the control display (**Fig.3**).
-  **N.B.:** If the flow is adjusted to "H2O 0" is no emission of detergent solution.

SILENT-MAX FUNCTION

This machine has a SILENT-MAX function for reducing the noise generated by the suction motor. The SILENT function is always active in the machine by default. To deactivate the SILENT function, press the button (4) on the control panel (**Fig.2**).

-  **N.B.:** When the SILENT function is active, "LO" will appear on the control display (**Fig.4**).
-  **N.B.:** When the MAX function is active, "HI" will appear on the control display (**Fig.5**).

ALARM SCREEN

If an error occurs, the control display will show the corresponding alarm screen (**Fig. 6**), the screen will remain visible until the error has been resolved. When an error occurs, do as follows:

1. Stop the machine immediately.
2. If the error persists, switch off the machine and wait a few minutes before switching it back on.
3. If the error continues, read the following table:

CODE	DESCRIPTION	POSSIBLE CAUSE	SOLUTION
ALL_3	Low voltage	The function board has detected a low battery voltage level.	Recharge the batteries, if the problem continues replace the batteries.
ALL_49	Amperometric - brush output 1	The function board has detected an excessive load on the brush head group.	Stop the machine and lighten the pressure on the brush(es). If the alarm continues, turn off the machine and contact the nearest service centre.
ALL_52	Amperometric - vacuum cleaner output 1	The function board has detected an excessive load on the vacuum head.	Stop the machine and check that the vacuum head is not obstructed (see " SQUEEGEE BODY CLEANING "; CLEANING THE RECOVERY TANK FILTERS " CLEANING THE VACUUM TUBE "). If the alarm continues, turn off the machine and contact the nearest service centre.
ALL_90	Lever pushed	The function board detected that the operator presence levers have been pushed when starting the machine.	Release the operator presence levers.

 **WARNING:** In the case of any other alarm screen other than those indicated above, turn off the machine and contact the nearest service centre.

AT THE END OF THE WORK

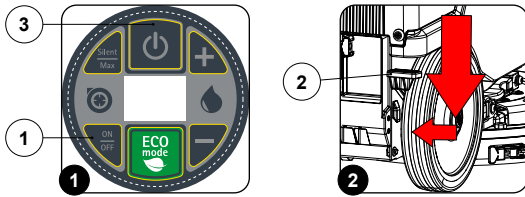

At the end of the work, and before carrying out any type of maintenance, perform the following operations:

1. If active, turn off the suction motor, press the "SUCTION MOTOR ACTIVATION DEACTIVATION" (1) switch on the control panel (Fig.1).
2. Lift the squeegee body, press the "SQUEEGEE CONTROL" pedal (2) at the rear right of the machine (Fig.2).
3. Turn off the machine by pressing the stand-by switch (3) on the control panel (Fig.3).
4. Take the appliance to the dedicated dirty water drainage area.
5. Carry out all the procedures listed in the chapter "ROUTINE MAINTENANCE" on page 20, indicated in the column entitled AT THE END OF THE WORK.
6. Once the routine maintenance operations have been completed, take the machine to the area designated for storage.

⚠ ATTENTION: Park the machine in an enclosed place, on a flat surface, and at a safe distance from any objects that could either damage it or be damaged due to contact with the machine itself.

7. Secure the machine, see paragraph "MACHINE SAFETY" on page 11.

ROUTINE MAINTENANCE

TYPE OF MAINTENANCE	AT THE END OF THE WORK	DAILY	WEEKLY	LONG PERIOD OF NON-USE	TRANSPORT
DRAINING THE RECOVERY TANK	X			X	X
CLEANING THE SQUEEGEE BODY	X	X		X	
CLEANING THE BRUSH HEAD BRUSH		X		X	
CLEANING THE RECOVERY TANK FILTERS		X		X	
EMPTYING THE SOLUTION TANK		X		X	X
CLEANING THE WATER SYSTEM FILTER		X		X	
CLEANING THE VACUUM TUBE		X		X	
CLEANING THE RECOVERY TANK			X	X	

Before carrying out any routine maintenance operations, proceed as follows:

1. Take the machine to the maintenance area.

⚠ WARNING: the place designated for this operation must comply with current regulations concerning safety at work and current environmental protection regulations.

2. Carry out the steps necessary to secure the machine (see chapter "MACHINE SAFETY" on page 11).

🧤 ATTENTION: It is recommended to wear the appropriate PPE (Personal Protective Equipment), suitable for the work to be carried out.

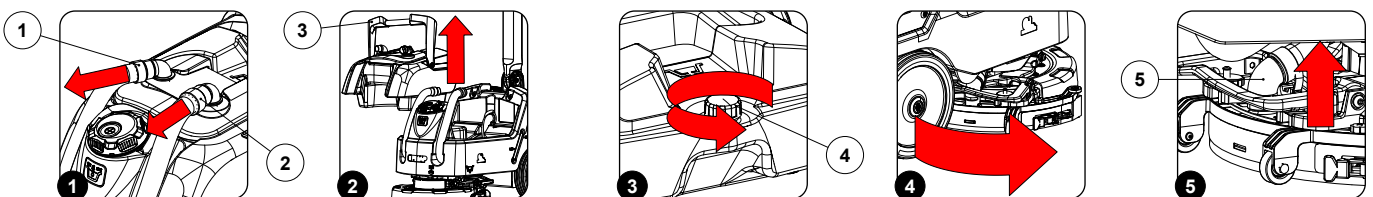

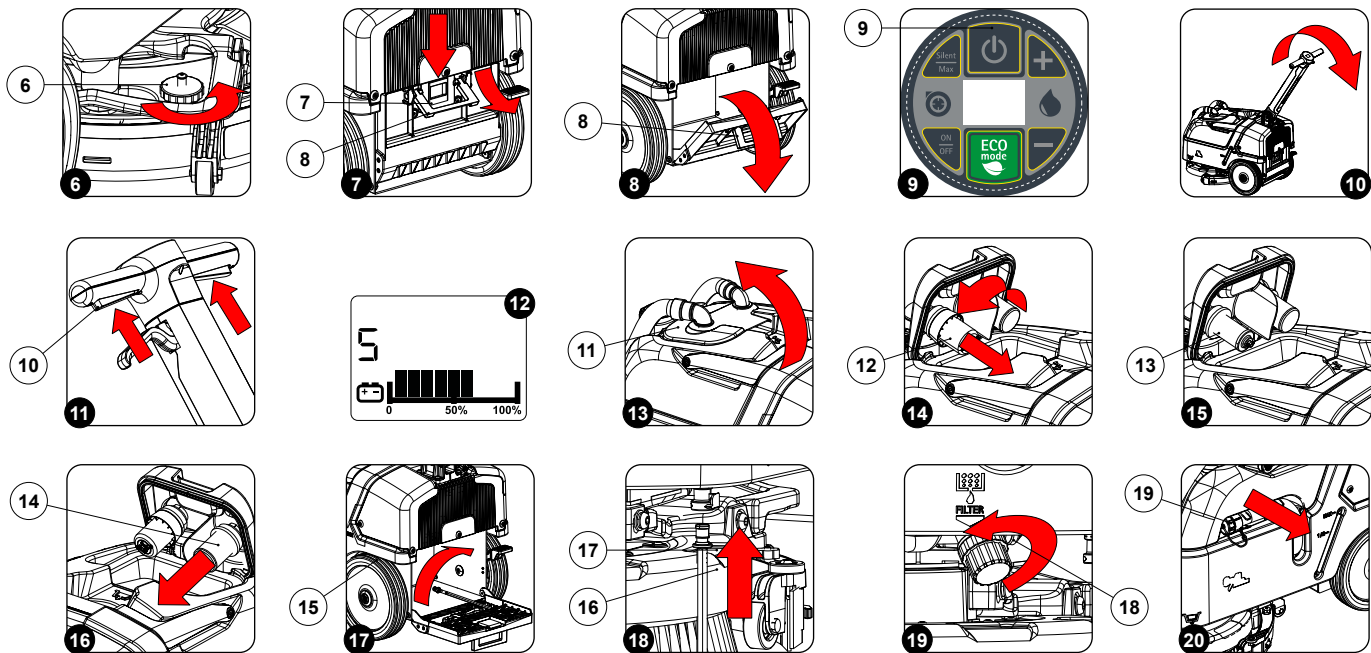

DRAINING THE RECOVERY TANK

To empty the recovery tank of Evo machines, proceed as follows:

1. Disconnect the suction motor tube (1) from the sleeve in the recovery tank cover (Fig.1).
2. Disconnect the squeegee tube (2) from the sleeve in the recovery tank cover (Fig.1).
3. Use the handle (3) to remove the recovery tank (Fig.2) from the machine.
4. Unscrew the dumping system cap (4) of the recovery tank (Fig.3).
5. Empty the recovery tank.

 **N.B.:** the place designated for this operation must comply with current environmental protection regulations.

6. Repeat the operations in reverse order to reassemble all the parts.

To empty the recovery tank of XL machines, proceed as follows:

1. Release the recovery tank drainage tube (19) (on the left-hand side of the machine) from the retainers (Fig.20).
2. Bend the end of the drainage tube, so as to create a choke and prevent the contents from coming out, put the tube on the discharge surface, unscrew the cap and gradually release the tube.
3. Empty the recovery tank.

 **N.B.:** the place designated for this operation must comply with current environmental protection regulations.

4. Repeat the operations in reverse order to reassemble all the parts.

CLEANING THE SQUEEGEE BODY

The careful cleaning of the whole vacuum unit ensures better drying and cleaning of the floor as well as a longer vacuum motor life. To carry out the cleaning of the squeegee body, proceed as follows:

1. Move to the front right of the machine and turn the squeegee support counter-clockwise (Fig.4).
2. Unscrew the squeegee tube (5) from the nozzle on the squeegee body (Fig.5)
3. Completely unscrew the knobs (6) on the squeegee body pre-assembly (Fig.6).
4. Remove the squeegee body from the slits in the squeegee connector.
5. Thoroughly clean the vacuum chamber with a jet of water, and then with a damp cloth.
6. Thoroughly clean the rear rubber blade with a jet of water, and then with a damp cloth.
7. Thoroughly clean the front rubber blade with a jet of water, and then with a damp cloth.

 **N.B.:** If necessary, replace the squeegee rubber blades (see paragraph "REPLACING THE SQUEEGEE BODY RUBBER BLADES" on page 24).

8. Thoroughly clean the vacuum nozzle with a jet of water, and then with a damp cloth.
9. Proceed in the opposite order to reassemble all the parts.

CLEANING THE BRUSH HEAD BRUSH (SCRUBBING VERSIONS)

Careful cleaning of the brush guarantees better cleaning of the floor as well as a longer brush head gearmotor lifespan. To clean the brush, proceed as follows:

1. Move to the rear of the machine, press the uncoupling lever (7) (Fig.7) and open the battery compartment closing carter, using the handle (8) (Fig.8).

 **ATTENTION:** the following operations must be carried out by qualified personnel. An incorrect connection of the connector may cause a malfunction of the device.

2. Connect the battery connector to the electrical system connector.
3. Reclose the battery compartment closure carter, make sure that the retainer system is correctly engaged.
4. Activate the machine by pressing the button (9) located on the control panel (Fig.9).
5. Lift the front of the machine from the control panel (Fig.10).
6. Pressing the operator presence lever (10) (Fig.11) three times activates the brush uncoupling function.

 **N.B.:** Once the brush uncoupling sequence has started, the symbol "5" appears on the control display (Fig.12).

 **ATTENTION:** during this operation, check there are no people or objects near the machine.

7. Clean the brush under a stream of running water to remove any impurities from its bristles. Check the wear status of the bristles and replace the brushes if they are excessively consumed (the bristles' protrusion must not be less than 10 mm; this distance is indicated on the brush by the yellow band). See paragraph "ASSEMBLING THE BRUSH HEAD BRUSH (SCRUBBING VERSION)" on page 14 for information on replacing the brush.
8. After checking to make sure that the brush is clean, reassemble it.

CLEANING THE RECOVERY TANK FILTERS

In order to clean the filters present inside the recovery tank, do the following:

1. Move to the front of the machine.
2. Remove the recovery tank cover (11) (Fig.13).
3. Remove the floating guard (12) by turning it clockwise (Fig.14).
4. Remove the suction motor filter (13) (Fig.15).
5. Clean the brush under a stream of running water to remove any impurities.

 **N.B.:** Use a spatula or brush to eliminate any dirt that is particularly difficult to remove.

6. Refit the suction motor filter and the floating guard.
7. Remove the squeegee filter (14) (Fig.16).
8. Clean the brush under a stream of running water to remove any impurities.

 **N.B.:** Use a spatula or brush to eliminate any dirt that is particularly difficult to remove.

9. When all the components that have just been washed are dry, carry out the operations just described in reverse to insert them into the machine.

EMPTYING THE SOLUTION TANK

Proceed as follows to empty the solution tank:

1. Move to the rear of the machine, press the uncoupling lever (7) (Fig.7) and open the battery compartment closing carter, using the handle (8) (Fig.8).
2. Remove the solution tank dumping system tube (15) from its seat (Fig.17).
3. Move to the front left of the machine and insert the machine connector (16) located on the solution tank dumping system tube to the female connector (17) on the solution tank (Fig.18).
4. When the solution tank is empty, repeat the operations in the reverse order to reassemble all the parts.

CLEANING THE WATER SYSTEM FILTER

In order to clean the water system's filter, do the following:

1. Empty the solution tank, see paragraph "EMPTYING THE SOLUTION TANK" on page 22.
2. Go to the front left of the machine and remove the detergent solution filter cap (17) (Fig.19).
3. Rinse the filter cartridge under a jet of water, and use a brush to eliminate any impurities, if necessary.
4. Once the filter cartridge is clean, repeat the operations in the opposite order to reassemble all the parts.

CLEANING THE VACUUM TUBE

Careful cleaning of the vacuum hose guarantees better cleaning of the floor as well as a longer vacuum motor life. Proceed as follows to clean the vacuum hose:

1. Extract the vacuum tube (5) from the vacuum nozzle on the squeegee body (Fig.5).
2. Remove the vacuum tube (1) via the hole on the back of the recovery tank (Fig.1).
3. Rinse the inside of the vacuum hose with a jet of running water.
4. Repeat the operations in reverse order to reassemble all the parts.

CLEANING THE RECOVERY TANK

To clean the recovery tank of Evo machines, proceed as follows:

1. Disconnect the suction motor tube (1) from the sleeve in the recovery tank cover (Fig.1).
2. Disconnect the squeegee tube (2) from the sleeve in the recovery tank cover (Fig.1).
3. Use the handle (3) to remove the recovery tank (Fig.2) from the machine.
4. Unscrew the dumping system cap (4) of the recovery tank (Fig.3).
5. Rinse the inside of the recovery tank under a jet of running water.

i N.B.: Use a spatula or brush to eliminate any dirt that is particularly difficult to remove.

♻️ N.B.: the place designated for this operation must comply with current environmental protection regulations.

6. Repeat the operations in reverse order to reassemble all the parts.

To empty the recovery tank of XL machines, proceed as follows:

1. Disconnect the suction motor tube (1) from the sleeve in the recovery tank cover (Fig.1).
2. Disconnect the squeegee tube (2) from the sleeve in the recovery tank cover (Fig.1).
3. Use the handle (3) to remove the recovery tank (Fig.2) from the machine.
4. Release the recovery tank drainage tube (19) (on the left-hand side of the machine) from the retainers (Fig.20).
5. Unscrew the cap and lay the drainage tube over the drain well.
6. Rinse the inside of the recovery tank under a jet of running water.

i N.B.: Use a spatula or brush to eliminate any dirt that is particularly difficult to remove.

♻️ N.B.: the place designated for this operation must comply with current environmental protection regulations.

7. Repeat the operations in reverse order to reassemble all the parts.

EXTRAORDINARY MAINTENANCE

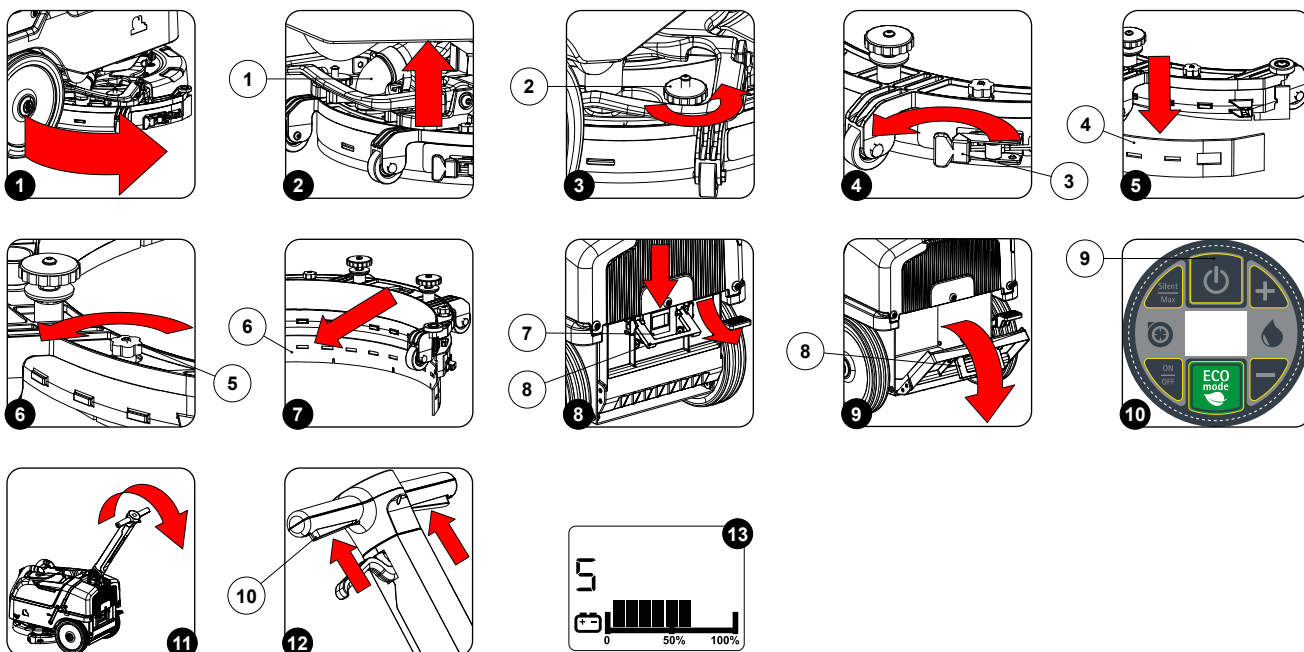

Before carrying out any extraordinary maintenance operations, proceed as follows:

1. Take the machine to the maintenance area.



WARNING: the place designated for this operation must comply with current regulations concerning safety at work and current environmental protection regulations.

2. Carry out the steps necessary to secure the machine (see chapter "MACHINE SAFETY" on page 11).



ATTENTION: It is recommended to wear the appropriate PPE (Personal Protective Equipment), suitable for the work to be carried out.

REPLACING THE SQUEEGEE BODY RUBBER BLADES

Ensuring the integrity of the squeegee body's rubber blades guarantees better floor cleaning and drying results, as well as a longer service life for the vacuum motor. In order to replace the squeegee body's rubber blades, do the following:

1. Move to the front right of the machine and turn the squeegee support counter-clockwise (**Fig.1**).
2. Unscrew the squeegee tube (1) from the nozzle on the squeegee body (**Fig.2**).
3. Completely unscrew the knobs (2) on the squeegee body pre-assembly (**Fig.3**).
4. Remove the squeegee body from the slits in the squeegee connector.
5. Remove the rear rubber blade compression plate, and release the stopper (3) at the rear of the squeegee (**Fig.4**).
6. Remove the rear rubber blade (4) from the squeegee body (**Fig.5**) and replace it with the new one.
7. Completely unscrew the knobs (5) in the squeegee body's pre-assembly (**Fig.6**).
8. Remove the front rubber blade (6) from the body inside the squeegee (**Fig.7**) and replace it with the new one.
9. Repeat the operations in reverse order to reassemble all the parts.



N.B.: It is recommended to replace both squeegee body blades in order to ensure good results when drying the floor.

REPLACING THE BRUSH HEAD BRUSH (SCRUBBING VERSION)

Ensuring the integrity of the brush will guarantee better floor cleaning results, and will extend the service life of the brush head's gearmotor. To replace the brush, proceed as follows:

1. Move to the rear of the machine, press the uncoupling lever (7) (**Fig.8**) and open the battery compartment closing carter, using the handle (8) (**Fig.9**).



ATTENTION: the following operations must be carried out by qualified personnel. An incorrect connection of the connector may cause a malfunction of the device.

2. Connect the battery connector to the electrical system connector.
3. Reclose the battery compartment closure carter, make sure that the retainer system is correctly engaged.
4. Activate the machine by pressing the button (9) located on the control panel (**Fig.10**).
5. Lift the front of the machine from the control panel (**Fig.11**).
6. Pressing the operator presence lever (10) (**Fig.12**) three times activates the brush uncoupling function.



N.B.: Once the brush uncoupling sequence has started, the symbol "5" appears on the control display (**Fig.13**).



ATTENTION: during this operation, check there are no people or objects near the machine.

7. Replace the brush with a new one (see paragraph "ASSEMBLING THE BRUSH HEAD BRUSH (SCRUBBING VERSION)" on page 14).

CHOOSING AND USING BRUSHES

POLYPROPYLENE BRUSH (PPL)

Used on all types of floors. Good resistance to wear and tear, and hot water (no greater than 50°C.). PPL is non-hygroscopic and therefore retains its characteristics even when working in wet conditions.

ABRASIVE BRUSH

The bristles of this type of brush are charged with highly aggressive abrasives. It is used to clean very dirty floors. To avoid floor damage, work only with the pressure strictly necessary.

BRISTLE THICKNESS

Thicker bristles are more rigid and are therefore used on smooth floors or floors with small joints.

On uneven floors or those with deep joints, it is advisable to use softer bristles which can enter the gaps more easily.

Remember that when the bristles are worn and therefore too short, they will become rigid and are no longer able to penetrate and clean deep down. In this case, like with over-large bristles, the brush tends to jump.

PAD HOLDER

The pad holder is recommended for cleaning shiny surfaces.

There are two types of pad holder:

- The traditional pad holder is fitted with a series of anchor points that allow the abrasive floor pad to be held and dragged while working.
- the CENTRE LOCK type pad holder not only has anchor points, but also a snap-type central locking system in plastic that allows the abrasive floor pad to be perfectly centred and held without any risk of it becoming detached. This type of pad holder is recommended above all for machines with more than one brush, where the centring of the abrasive discs is difficult.

RED PAD

Suitable for frequent use on relatively clean floors. Even cleans without water, and polishes by removing marks.

GREEN PAD

Suitable for removing surface layers of wax and for preparing the flooring for subsequent treatments. For wet use.

BLACK PAD

Suitable for wet scraping heavy layers of wax. Removes the old finish, and eliminates burrs in concrete.

WHITE PAD

Suitable for finishing treated floors and for shiny polishing. Use dry or slightly damp.

BROWN PAD

Suitable for wet or dry scraping with wax removers. Prepare the floor for new waxing. Resistant to acids.

MACHINE	CODE	QTY	TYPE OF BRISTLE	COLOUR	NOTES
Evo	451751	1	PPL Ø0,35	VERDE	BRUSH Ø _F =340mm Ø _E =356mm
	451752	1	PPL Ø0,6	BIANCO	
	451753	1	PPL Ø0,9	NERO	
	451754	1	ABRASIVE Ø1	GRIGIO	
	451755	1	-		PAD HOLDER Ø _F =340mm Ø _P =356mm
XL	451780	1	PPL Ø0,35	VERDE	BRUSH Ø _F =410mm Ø _E =432mm
	451781	1	PPL Ø0,6	BIANCO	
	451782	1	PPL Ø0,9	NERO	
	451783	1	ABRASIVE Ø1	GRIGIO	
	451784	1	-		PAD HOLDER Ø _F =410mm Ø _P =432mm
XL Orbital	451785	1	-		PAD HOLDER Ø _F =410mm Ø _P =432mm

TROUBLESHOOTING

This chapter lists the most common problems linked with the use of the machine. If you are unable to resolve the problems with the information given here, please contact your nearest assistance centre.

PROBLEM	POSSIBLE CAUSE	SOLUTION
THE MACHINE DOES NOT START	The machine is in stand-by.	Press the machine's stand-by state activation - deactivation button.
	Check that when switched on there are no alarm messages on the command display.	Stop the machine immediately, and contact a specialised service centre.
	Make sure that the batteries are correctly connected to each other and that the battery connector is connected to the electrical system connector.	See paragraphs "INSERTING THE BATTERIES INTO THE MACHINE" on page 12 and "CONNECTING THE BATTERIES TO THE MACHINE'S ELECTRICAL SYSTEM" on page 12.
	Check the charge level of the batteries.	If the battery charge level is critical, perform a complete charge cycle (see paragraph "RECHARGING THE BATTERIES" on page 12).
THE BATTERIES ARE NOT CHARGED CORRECTLY (VERSIONS WITHOUT AN ON BOARD BATTERY CHARGER)	The connector of the battery charger cable is not properly inserted in the battery connector.	Connect the battery charger cable connector to the battery connector again.
	The plug on the battery charger's power cable is not correctly inserted into the electrical outlet.	Check that the battery charger power supply cable plug is connected to the mains socket.
	The characteristics of the mains power supply do not correspond to those required by the battery charger.	Check that the characteristics in the battery charger plate are the same as those of the mains supply.
	The LEDs of the battery charger blink repeatedly.	Referring to the battery charger use and maintenance manual, check the meaning of the flashing signals that the battery charger emits during the battery recharge stage.
THE BATTERIES ARE NOT CHARGED CORRECTLY (VERSIONS WITH AN ON BOARD BATTERY CHARGER)	The plug on the battery charger's cable is not correctly inserted into the socket on the battery charger itself.	Reconnect the battery charger's power cable.
	The plug on the battery charger's power cable is not correctly inserted into the electrical outlet.	Check that the battery charger power supply cable plug is connected to the mains socket.
	The characteristics of the mains power supply do not correspond to those required by the battery charger.	Check that the characteristics in the battery charger plate are the same as those of the mains supply.
	The LEDs of the battery charger blink repeatedly.	Referring to the battery charger use and maintenance manual, check the meaning of the flashing signals that the battery charger emits during the battery recharge stage.
THE MACHINE HAS A VERY LOW WORK AUTONOMY	Check the battery charge level, check the symbol on the command display.	If the battery charge level is critical, perform a complete charge cycle (see paragraph "RECHARGING THE BATTERIES" on page 12).
INSUFFICIENT DETERGENT SOLUTION ON THE BRUSHES	The quantity of detergent solution in the water system is not sufficient for the work to be carried out.	Check that the amount of detergent solution present in the machine's water system is sufficient for the work to be carried out.
	Detergent solution filter obstructed.	Check that the detergent solution filter is not clogged; if it is, clean it (see paragraph "CLEANING THE WATER SYSTEM FILTER" on page 22).
THE MACHINE DOES NOT CLEAN CORRECTLY	Not enough detergent solution comes out.	Read the section INSUFFICIENT DETERGENT SOLUTION ON THE BRUSHES.
	The brushes have not been inserted correctly in the machine.	Check that the disc brushes are correctly inserted inside the machine (see paragraph "ASSEMBLING THE BRUSH HEAD BRUSH (SCRUBBING VERSION)" on page 14).
	The brush bristles are excessively worn.	Check the state of wear of the brush and, if necessary, replace it.

PROBLEM	POSSIBLE CAUSE	SOLUTION
THE SQUEEGEE DOES NOT DRY PERFECTLY	The vacuum unit is obstructed.	Check that the squeegee is free from obstructions (see paragraph "CLEANING THE SQUEEGEE BODY" on page 21).
		Check that the vacuum tube is free from obstructions (see paragraph "CLEANING THE VACUUM TUBE" on page 23).
	The cap on the recovery tank drainage tube is not properly positioned.	Check that the filters in the recovery tank are free from obstructions (see paragraph "CLEANING THE RECOVERY TANK FILTERS" on page 22).
	The recovery tank lid is not positioned correctly.	Check that the cap on the recovery tank drainage tube is positioned properly.
EXCESSIVE FOAM PRODUCTION	The recovery tank lid is not positioned correctly.	Check that the recovery tank lid is properly positioned on the machine.
	The detergent being used is not suitable.	Check that a low foam detergent has been used. If necessary, add a small quantity of anti-foam liquid to the recovery tank.
THE MACHINE DOES NOT VACUUM CORRECTLY	The floor is not very dirty.	Dilute the detergent more.
	The recovery tank is full.	Empty the recovery tank (see paragraph "DRAINING THE RECOVERY TANK" on page 21).
	The vacuum device is obstructed	Read the section THE SQUEEGEE DOES NOT DRY PERFECTLY.

DISPOSAL

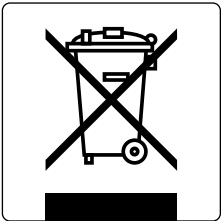

Dispose of the machine in accordance with the waste disposal regulations in force in the country in which the machine is being used.

EC DECLARATION OF CONFORMITY



The undersigned company:
Comac S.p.A.
Via Maestri del Lavoro, 13
37059 Santa Maria di Zevio (VR)
declares under its sole responsibility that the products

FLOOR SCRUBBING MACHINES

mod. Vispa Evo Essential CB; Vispa XL Essential CB; Vispa XL Essential Orbital CB

comply with the requirements of the following Directives:

- 2006/42/EC: Machinery Directive.
- 2014/35/EC: Low Voltage Directive.
- 2014/30/EC: Electromagnetic compatibility directive.

They also comply with the following standards:

- EN 60335-1:2012/A11:2014
- EN 60335-2-72:2012
- EN 12100:2010
- EN 60335-2-29:2004/A2:2010
- EN 61000-6-2:2005/AC:2005
- EN 61000-6-3:2007/A1:2011/AC:2012
- EN 61000-3-2:2014
- EN 61000-3-3:2013
- EN 55014-1:2006/A1:2009/A2:2011
- EN 55014-2:2015
- EN 62233:2008/AC:2008

The person authorized to compile the technical file:

Mr. Giancarlo Ruffo
Via Maestri del Lavoro, 13
37059 Santa Maria di Zevio (VR) - ITALY

Santa Maria di Zevio (VR), 24/02/2020

Comac S.p.A.
Legal representative
Giancarlo Ruffo

Agent: COMAC S.p.A.
Via Maestri del Lavoro, n°13
37059 - S. Maria di Zevio (VR) - Verona - Italia
Tel. 0039 045 8774222
Fax. 0039 045 8750303
E-mail: com@comac.it
Web: www.comac.it

Manufacturer: FIMAP S.p.A.
Via Invalidi del Lavoro, n°1
37059 - S. Maria di Zevio (VR) - Verona - Italia
Tel. 0039 045 6060491
Fax. 0039 045 6060440
E-mail: service@fimap.com
Web: www.fimap.com

EC DECLARATION OF CONFORMITY



The undersigned company:
Comac S.p.A.
Via Maestri del Lavoro, 13
37059 Santa Maria di Zevio (VR)
declares under its sole responsibility that the products

FLOOR SCRUBBING MACHINES

mod. Vispa Evo Essential; Vispa XL Essential; Vispa XL Essential Orbital

comply with the requirements of the following Directives:

- 2006/42/EC: Machinery Directive.
- 2014/30/EC: Electromagnetic compatibility directive.

They also comply with the following standards:

- EN 60335-1:2012/A11:2014
- EN 60335-2-72:2012
- EN 12100:2010
- EN 61000-6-2:2005/AC:2005
- EN 61000-6-3:2007/A1:2011/AC:2012
- EN 62233:2008/AC:2008

The person authorized to compile the technical file:

Mr. Giancarlo Ruffo
Via Maestri del Lavoro, 13
37059 Santa Maria di Zevio (VR) - ITALY

Santa Maria di Zevio (VR), 24/02/2020

Comac S.p.A.
Legal representative
Giancarlo Ruffo

Agent: COMAC S.p.A.
Via Maestri del Lavoro, n°13
37059 - S. Maria di Zevio (VR) - Verona - Italia
Tel. 0039 045 8774222
Fax. 0039 045 8750303
E-mail: com@comac.it
Web: www.comac.it

Manufacturer: FIMAP S.p.A.
Via Invalidi del Lavoro, n°1
37059 - S. Maria di Zevio (VR) - Verona - Italia
Tel. 0039 045 6060491
Fax. 0039 045 6060440
E-mail: service@fimap.com
Web: www.fimap.com

